

Datenblatt:

DB 7*0+129*+00* Attenzia task base plate

Lighting



Ausgegeben von iprint am 12.04.2019 / 14:42

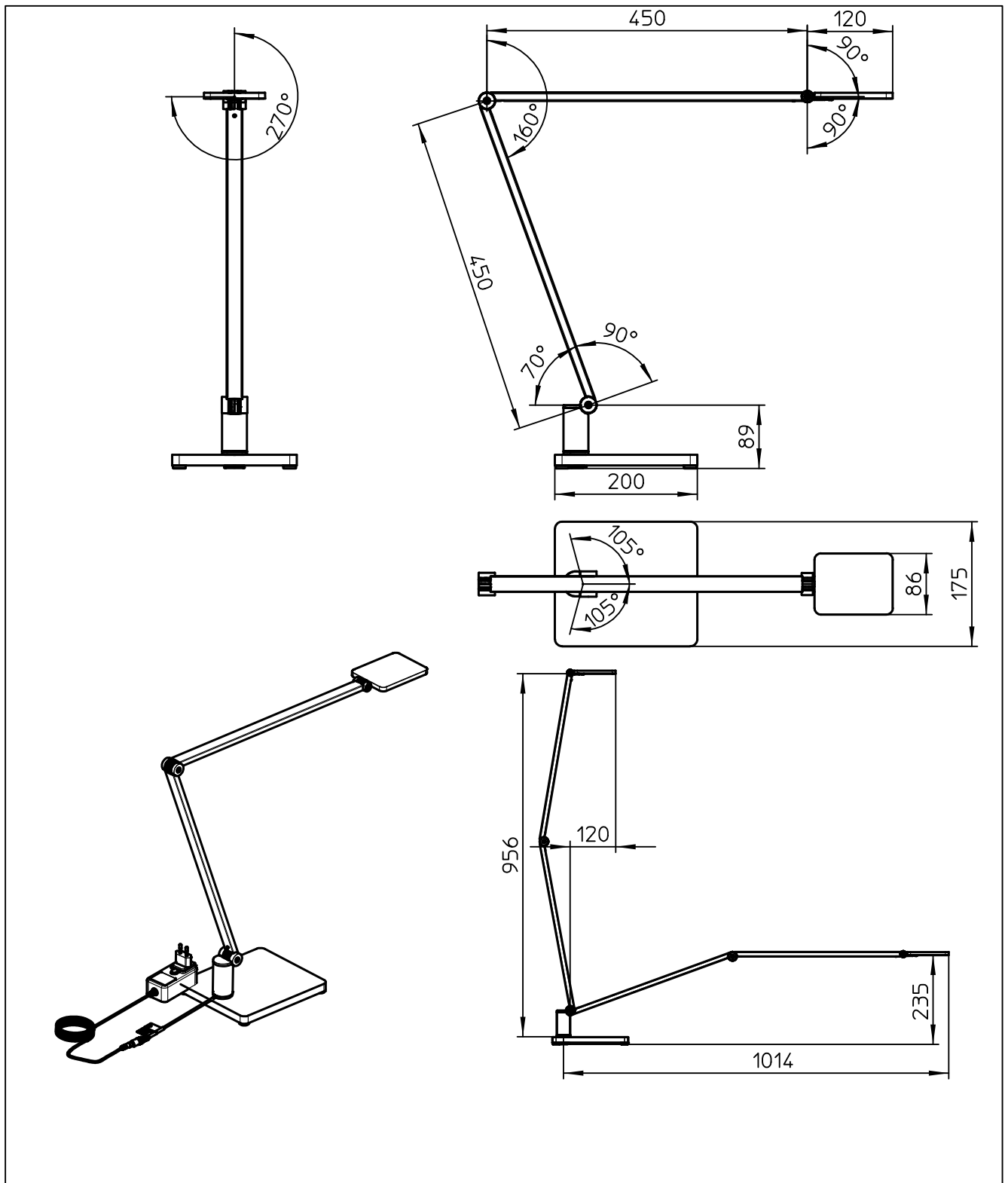

Ident.-Nr.:	Benennung:	Netzteil:
7*0+129*+000	Attenzia task base plate	
7*0+129*+002	Attenzia task US base plate	US